

Glen Oaks Office Park

v. 442

1001-1045 West Glen Oaks Lane, Mequon, WI 53092



For Available Suites Please Visit www.mikkelsonbuilders.com

Ownership

Glen Oaks Office Park is owned and operated by Mikkelson Builders. By combining ownership and management, you are assured of a hands on approach to satisfy all of your needs.

Description

Located just north of the intersection of Port Washington and Mequon Road and just west of I-43 on Glen Oaks Lane, Glen Oaks Office Park offers easy access to the Ozaukee community and is only 15 minutes from downtown Milwaukee.

Leasing

Mikkelson Builders leases are a two page document from Wisconsin Legal Blank. Our terms are simple and direct. We include:

- All triple net charges. Mikkelson Builders pays for utilities, insurance, taxes, cleaning, refuse, snow removal, landscaping, etc.
- Suites are based on useable sq. ft., not rentable sq. ft. You pay only for the space you occupy, not the halls, restrooms, lobbies, etc.
- Mikkelson Builders designs, owns, manages and leases their own buildings. This in-house approach allows them to build-out and lease space at a much lower cost than competitors.

Amenities

Post modern architecture and detailing with large operable windows
Close to shopping, banks, theaters, golf courses and restaurants
Custom designed office suites with free space planning
Shared green space w/ large Gazebo
Convenient and abundant surface parking
Single offices w/ access to a copier and conference room available

Contact Information

Bill Mikkelson
bill@mikkelsonbuilders.com
262-241-8740
www.mikkelsonbuilders.com

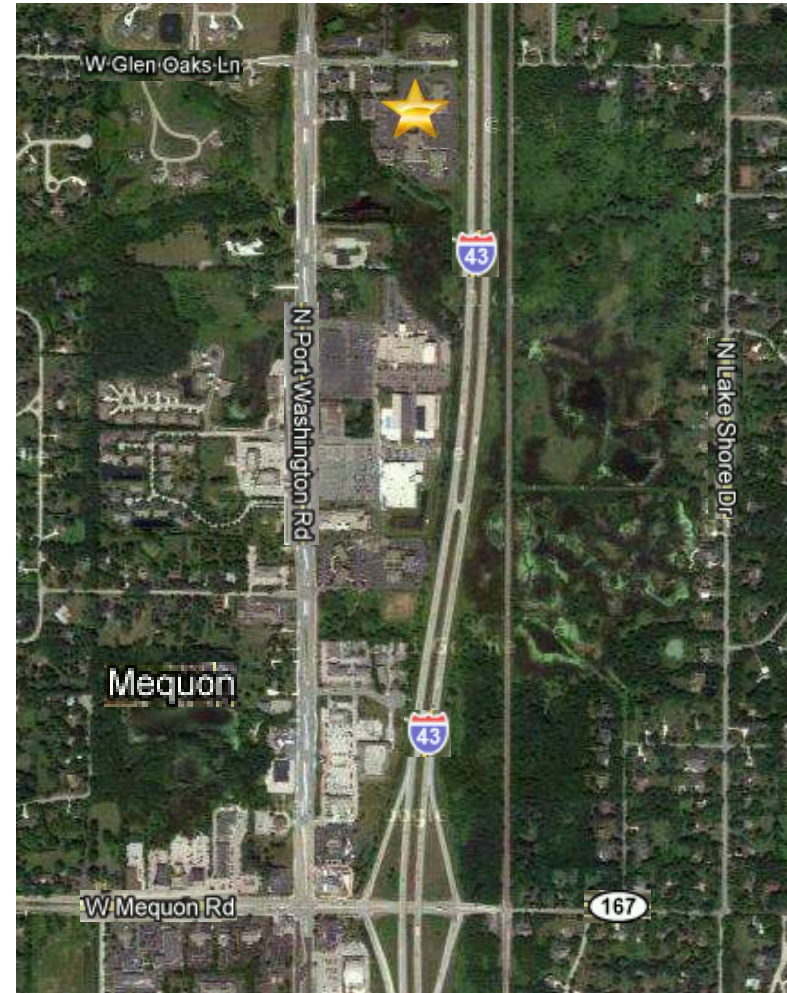

Building Innovation on Tradition

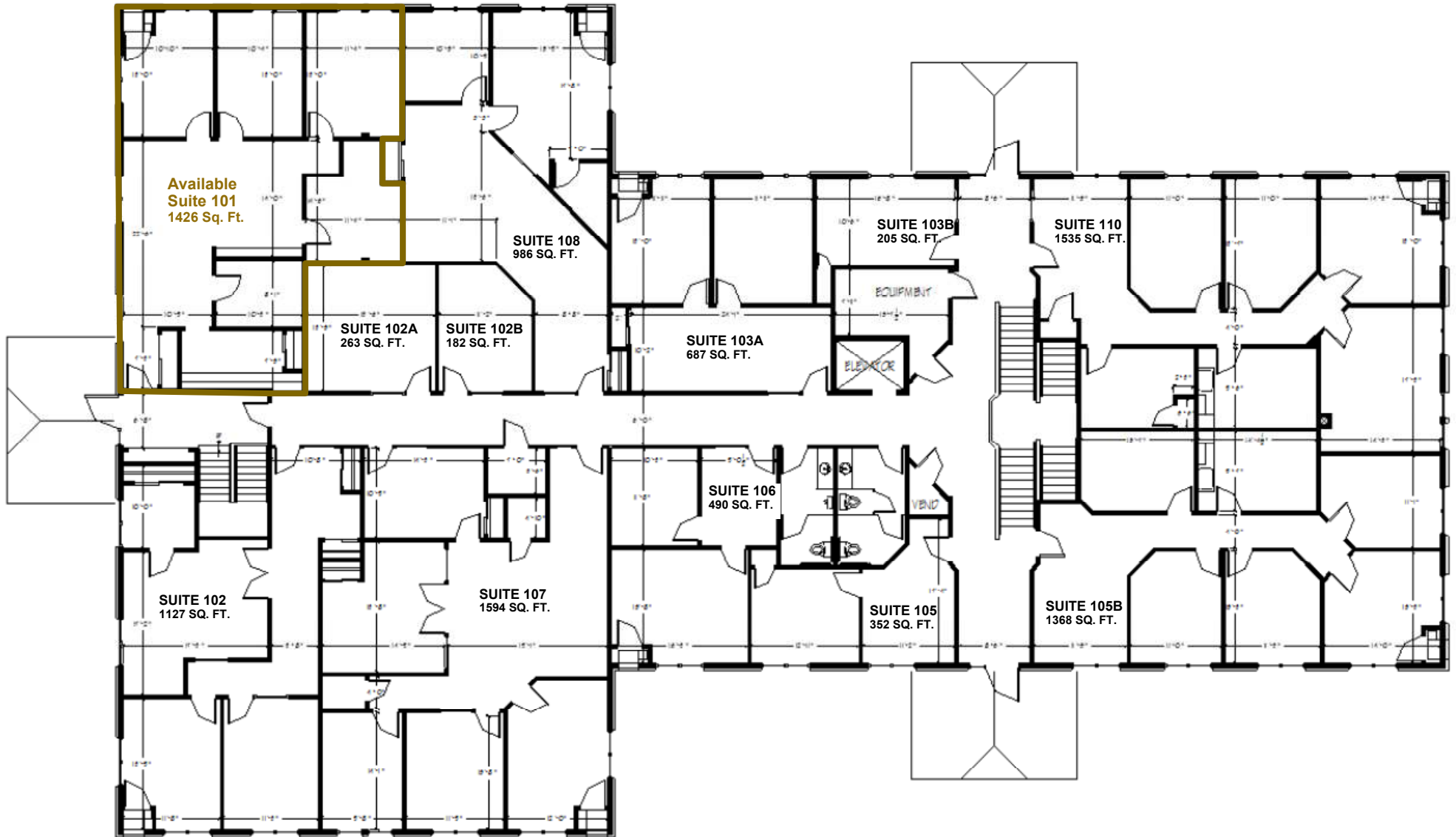

Building Innovation on Tradition



Building Innovation on Tradition

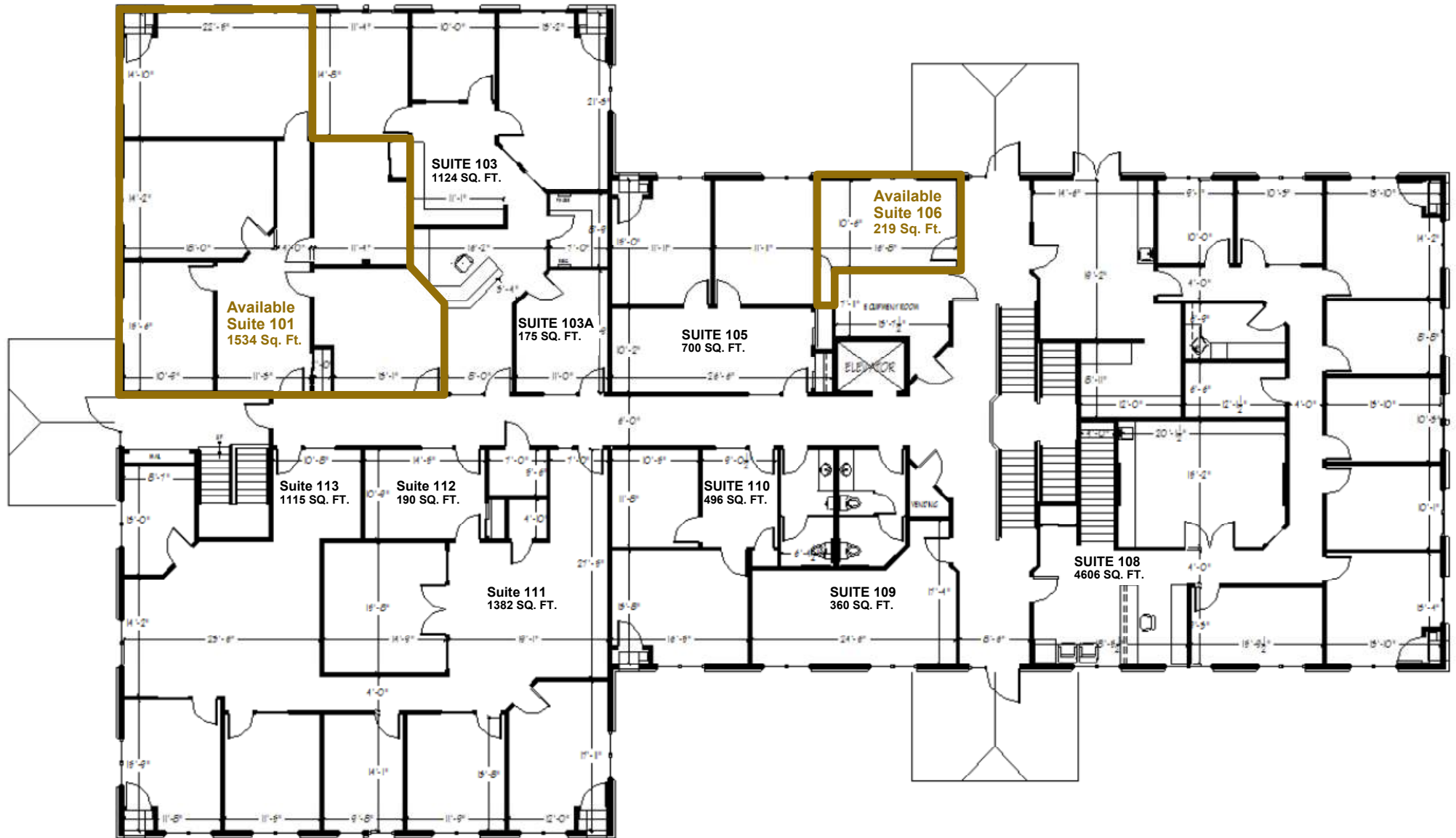

Building Innovation on Tradition

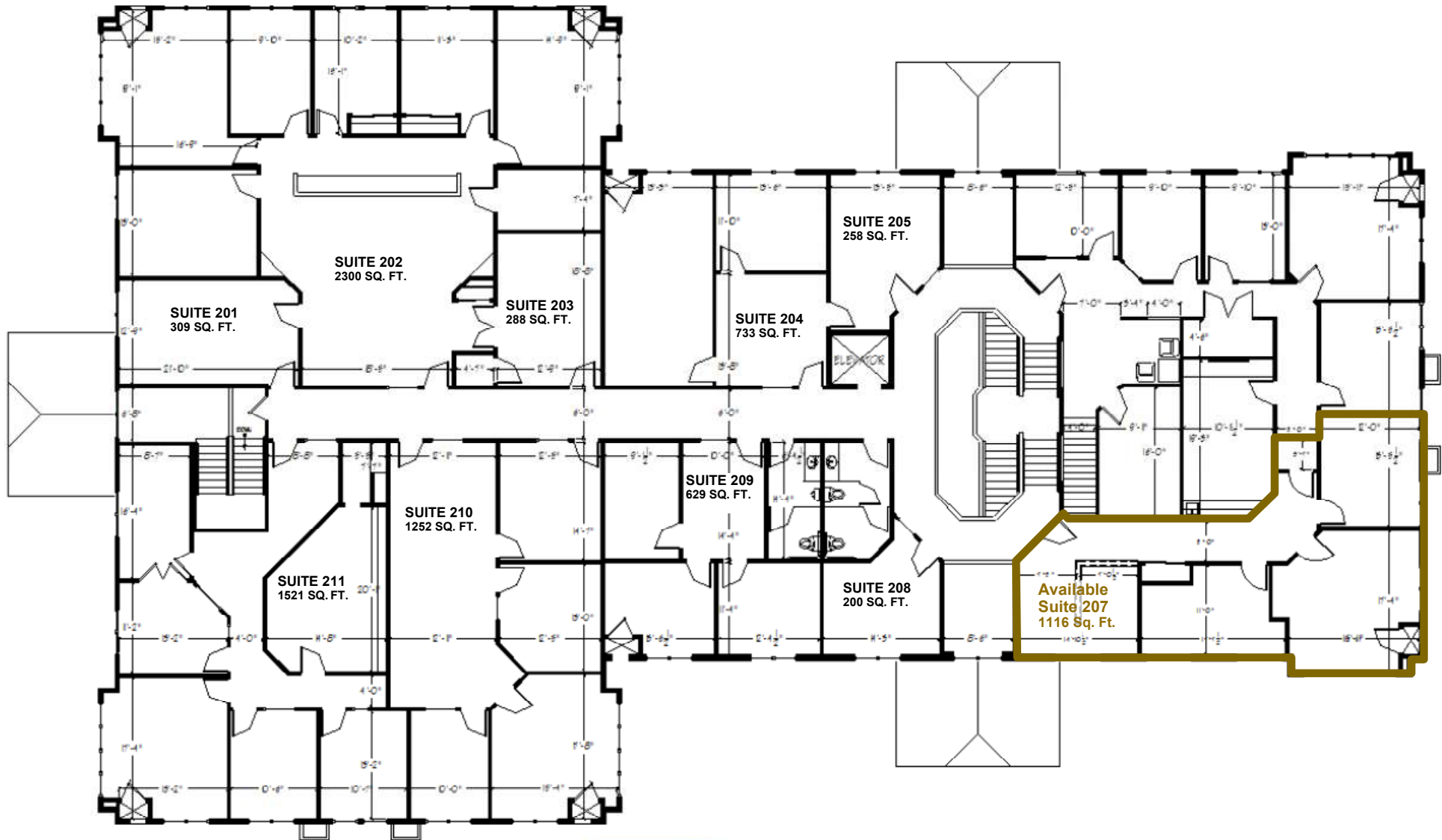

Building Innovation on Tradition

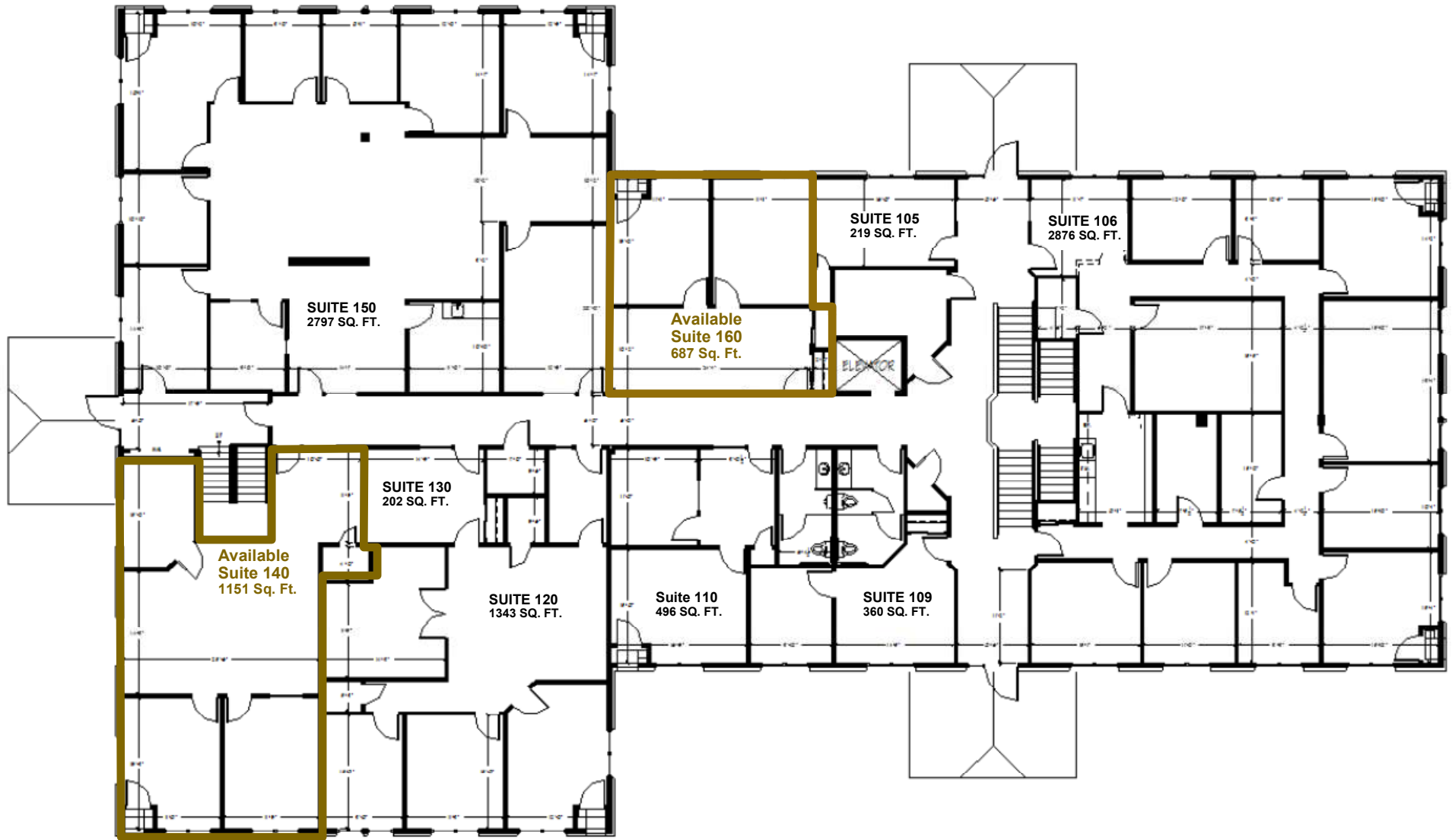

Building Innovation on Tradition

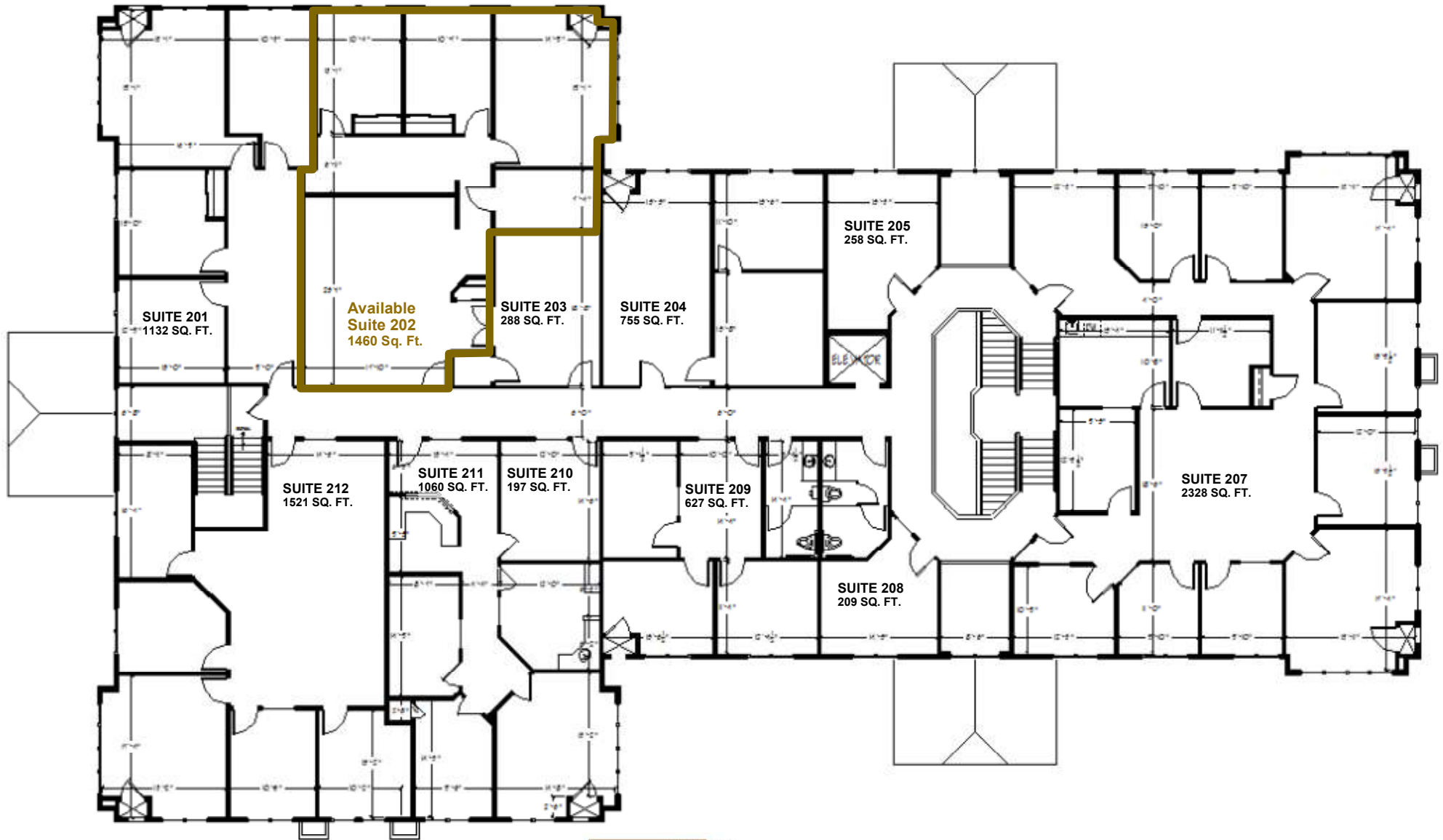

Building Innovation on Tradition

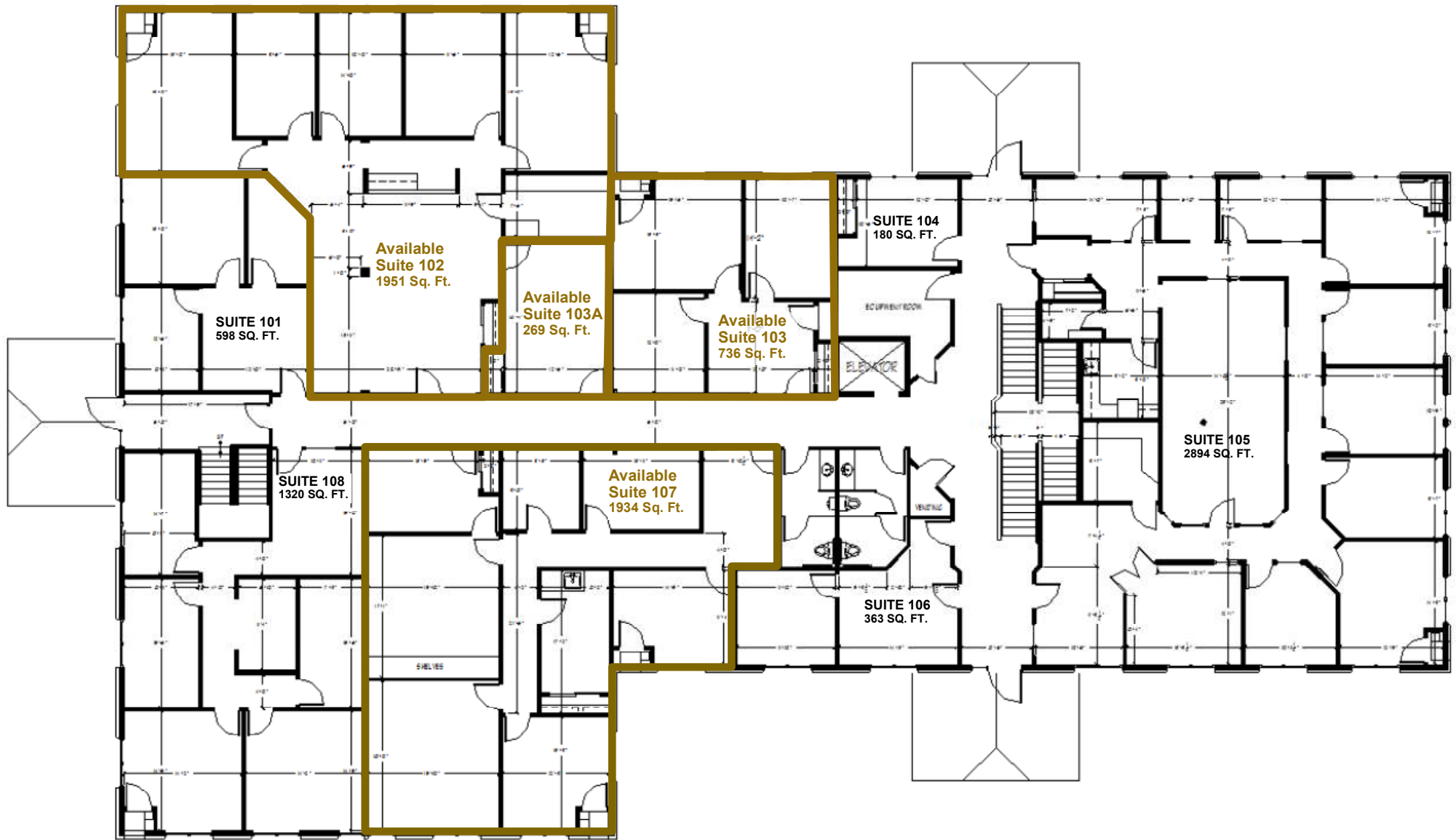

Building Innovation on Tradition

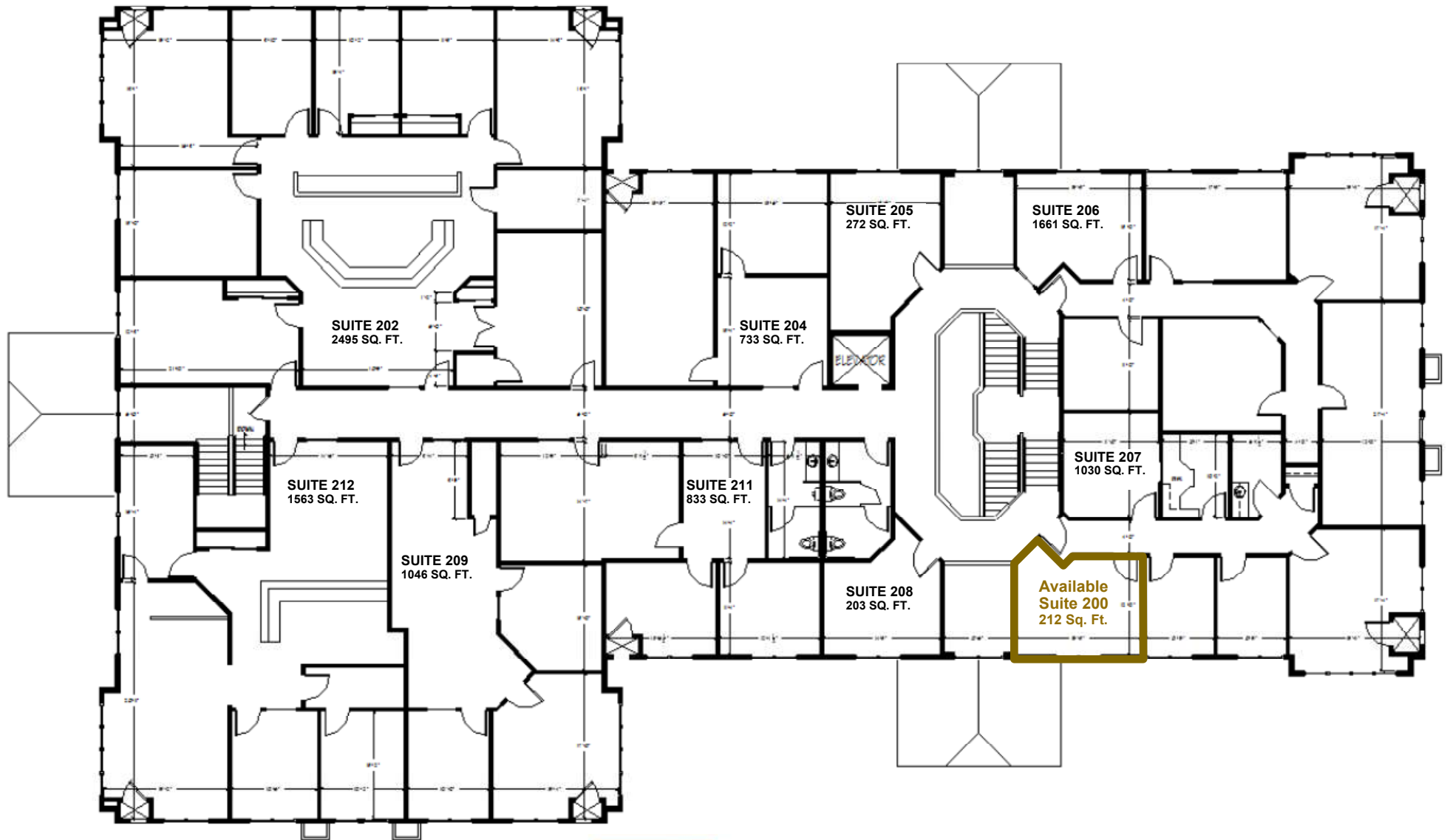

Building Innovation on Tradition

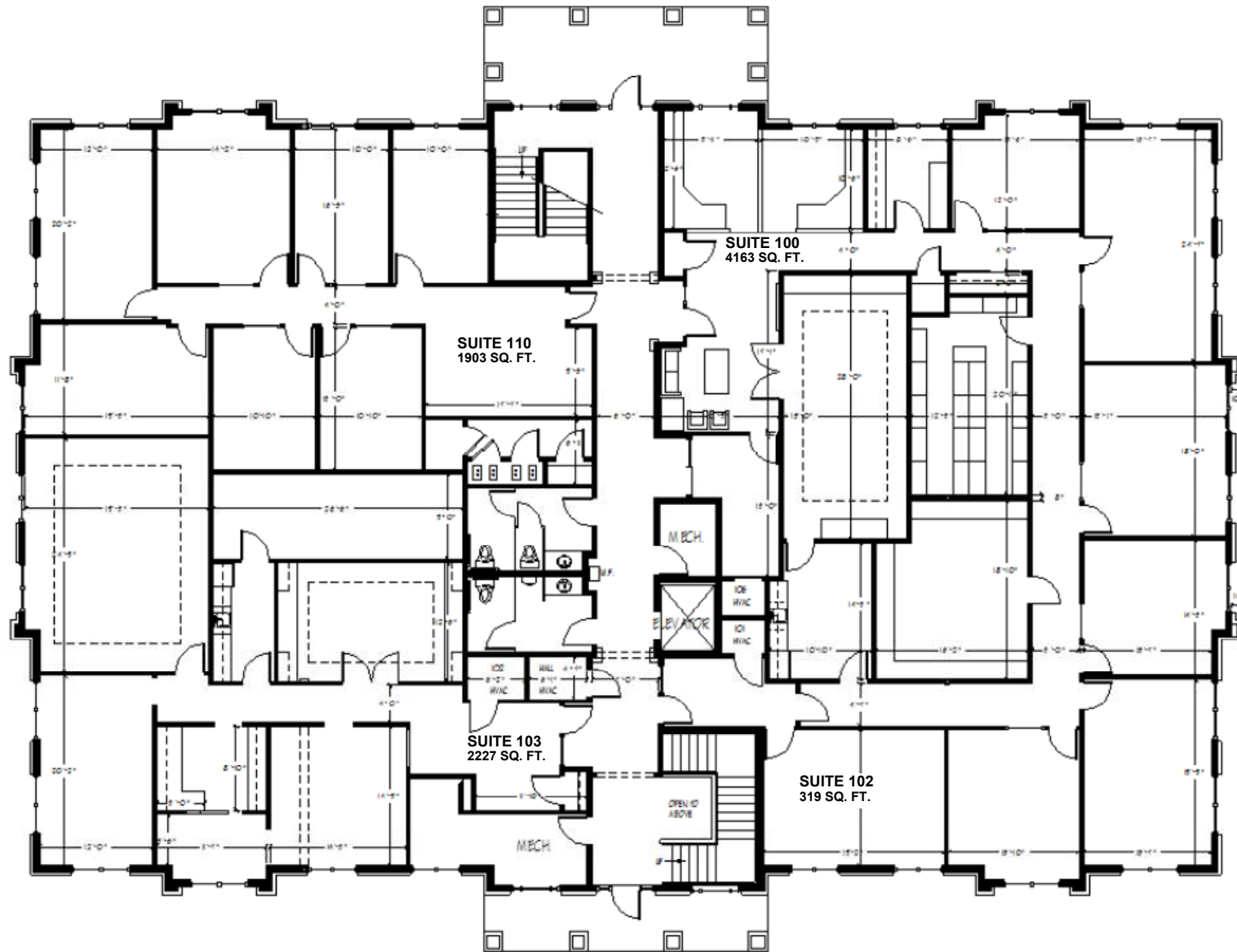

Building Innovation on Tradition

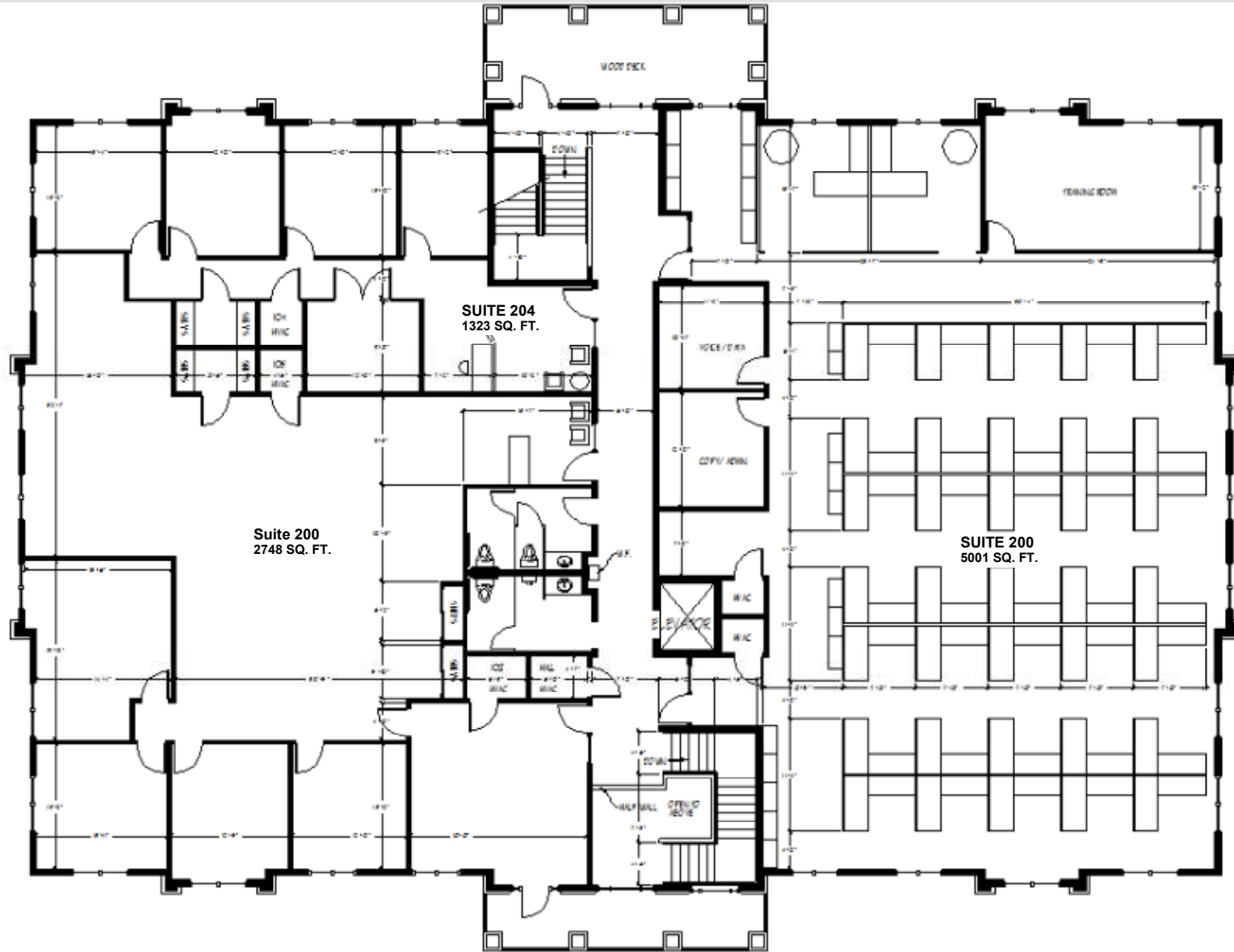

Building Innovation on Tradition

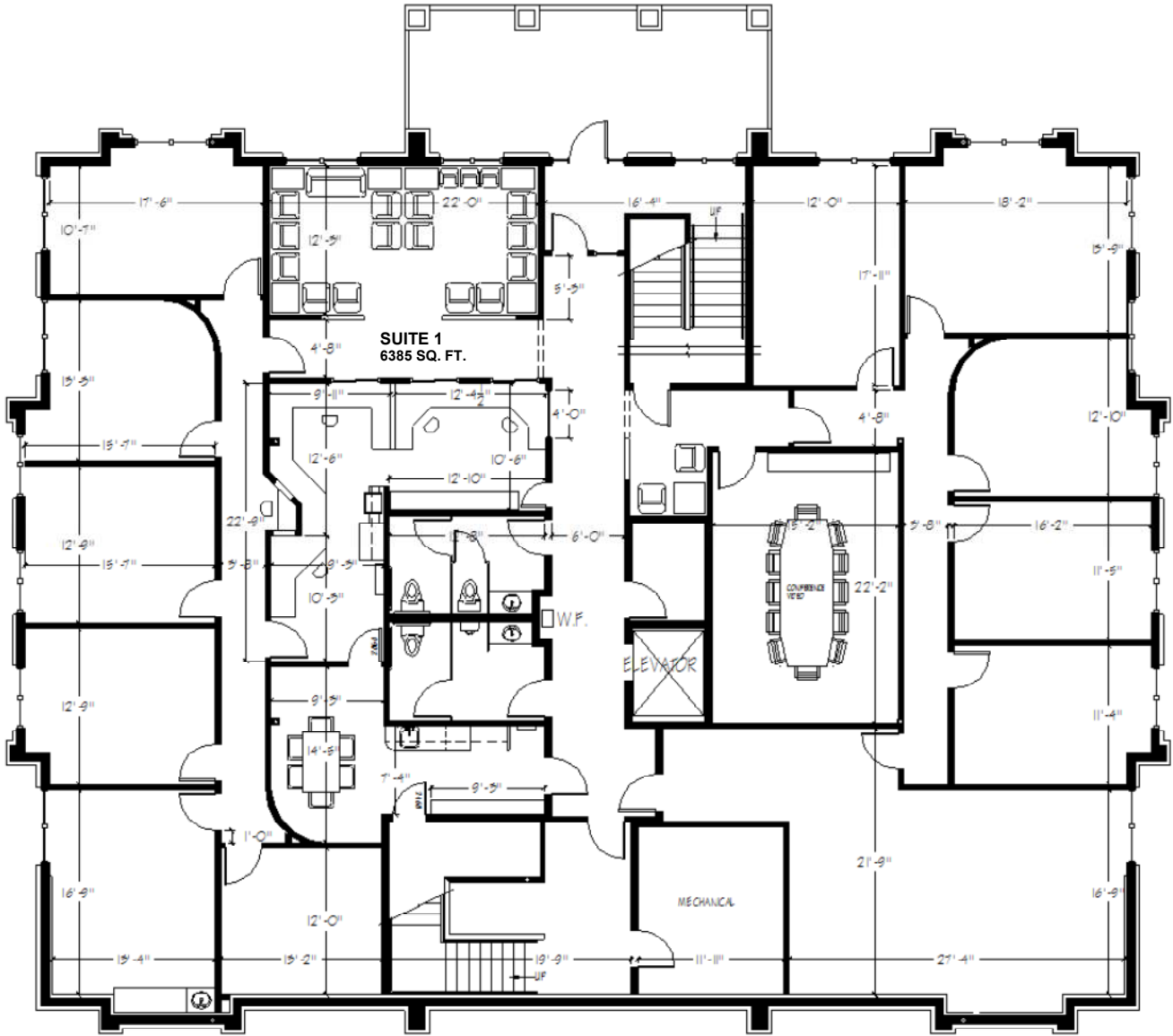

Building Innovation on Tradition

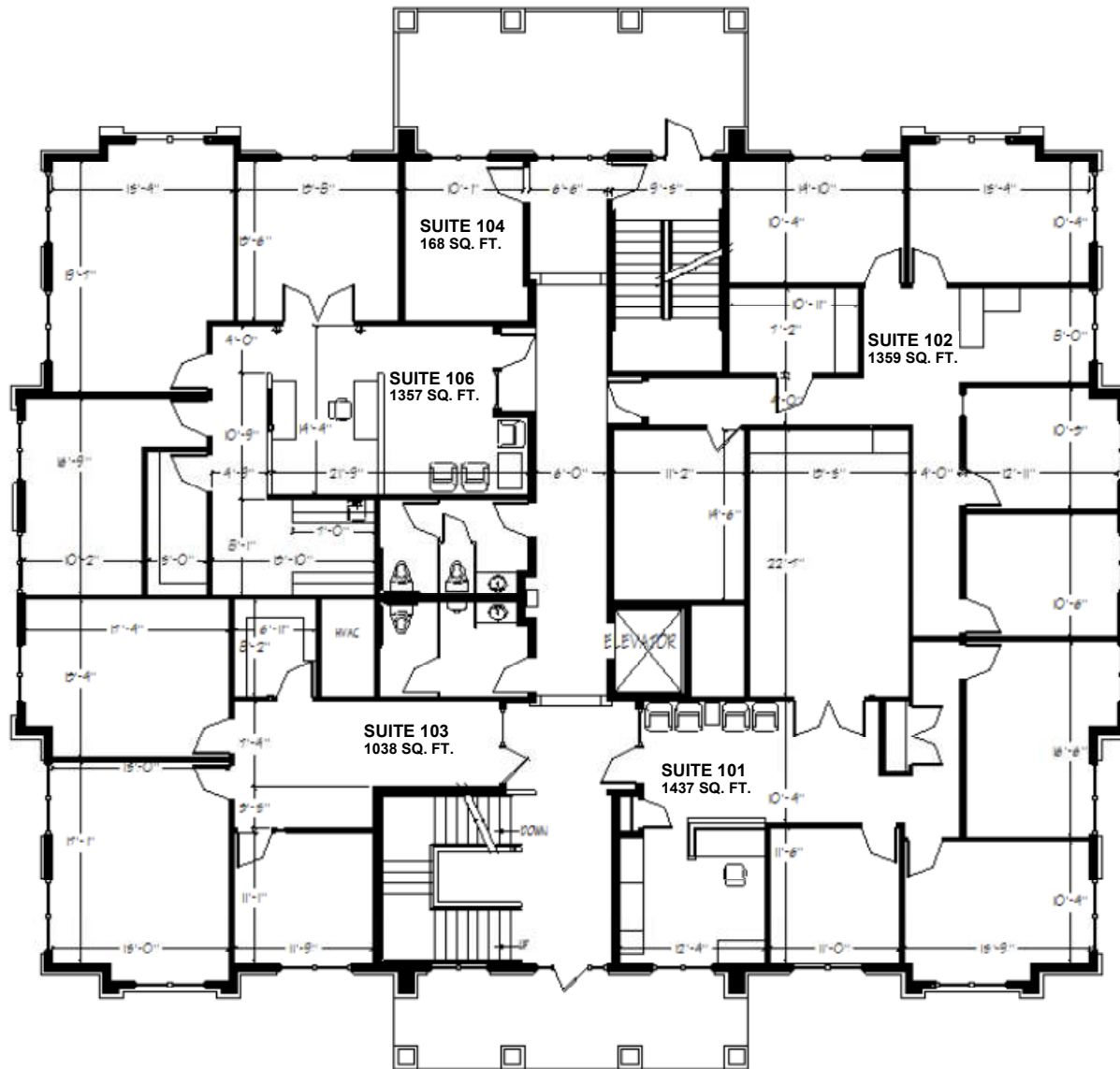

Building Innovation on Tradition

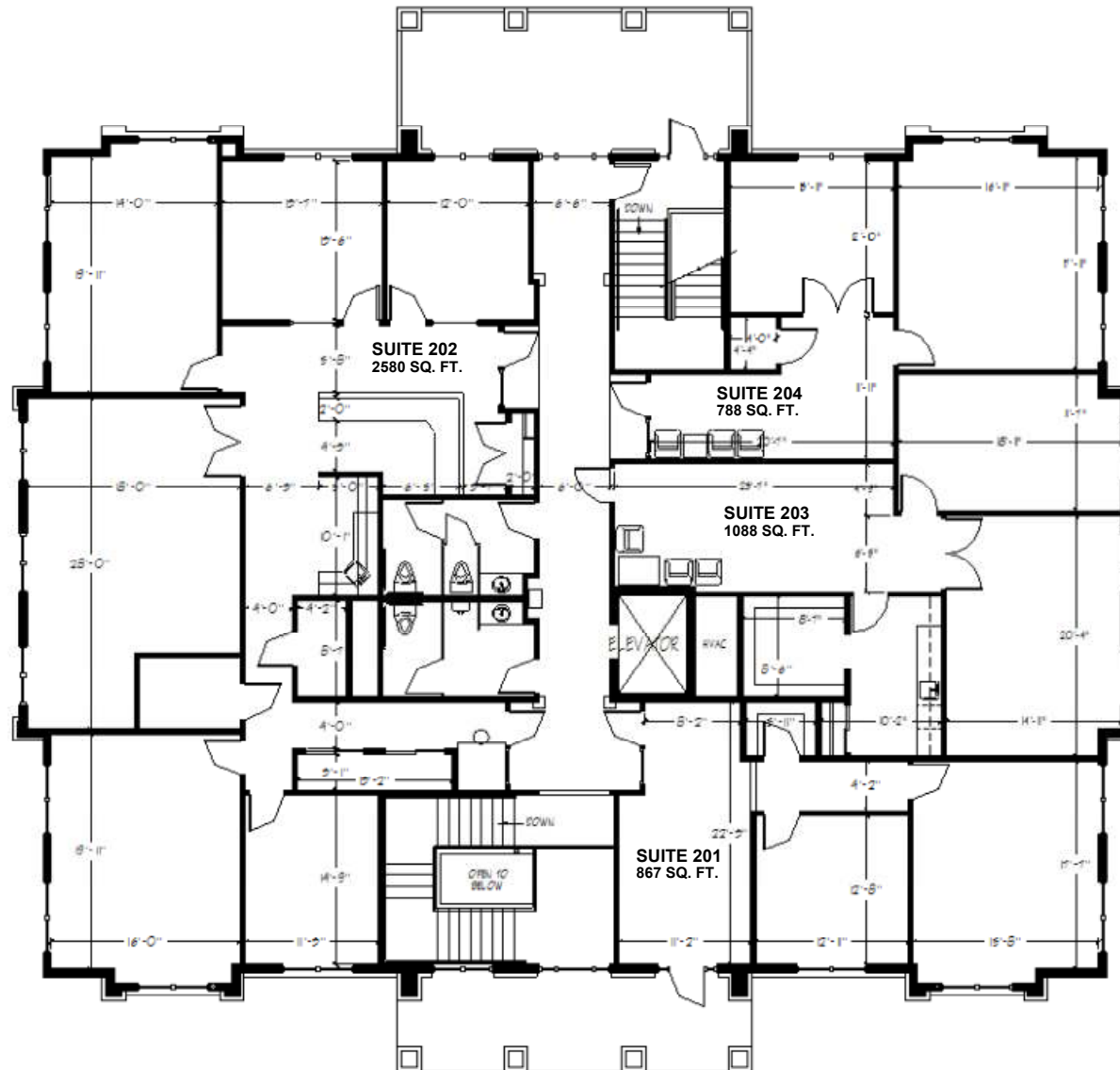

Building Innovation on Tradition

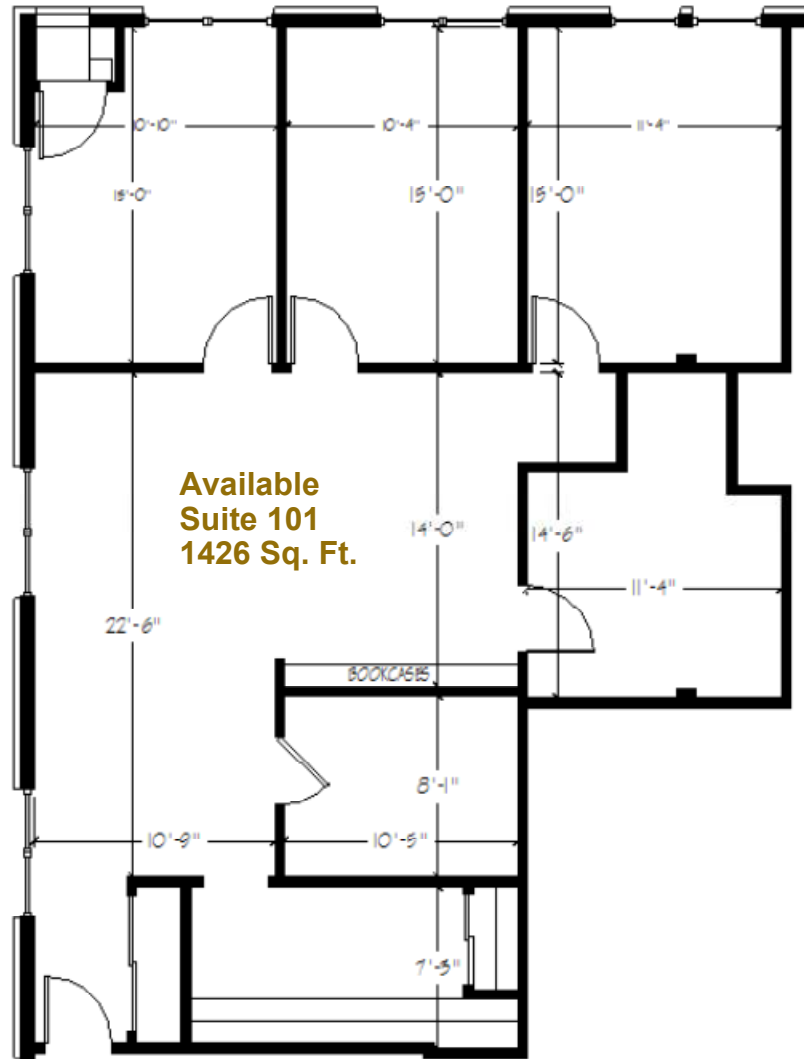

**Available
Suite 101
1426 Sq. Ft.**



Building Innovation on Tradition

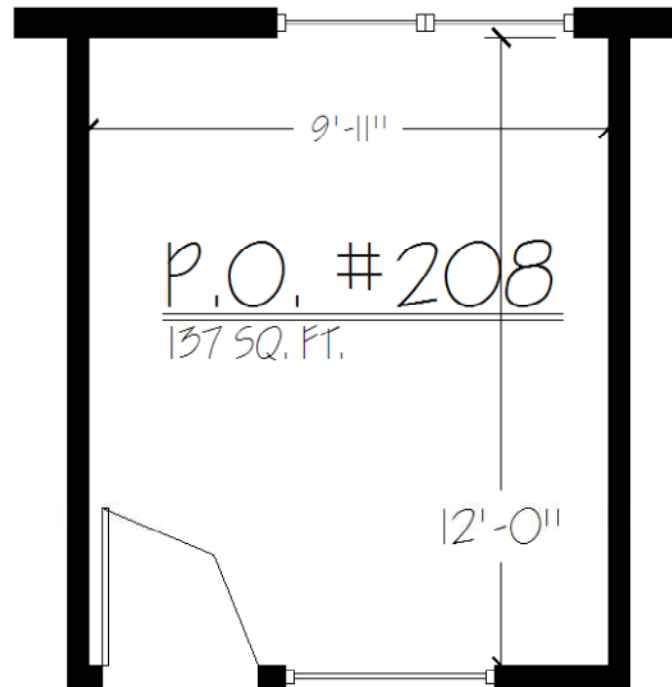

Building Innovation on Tradition

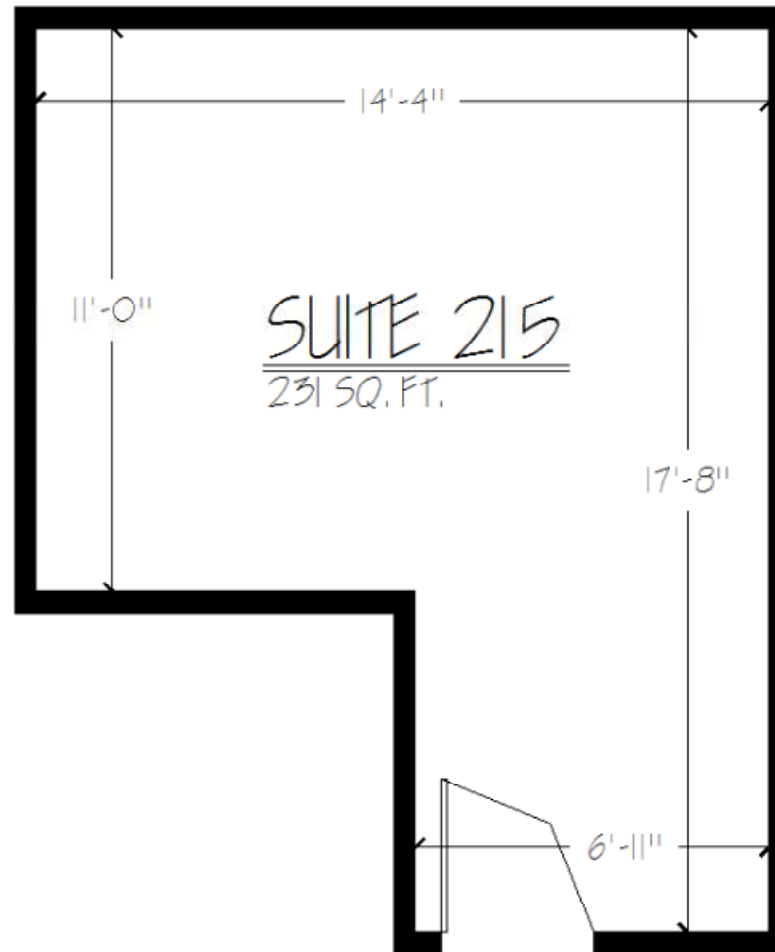

Building Innovation on Tradition

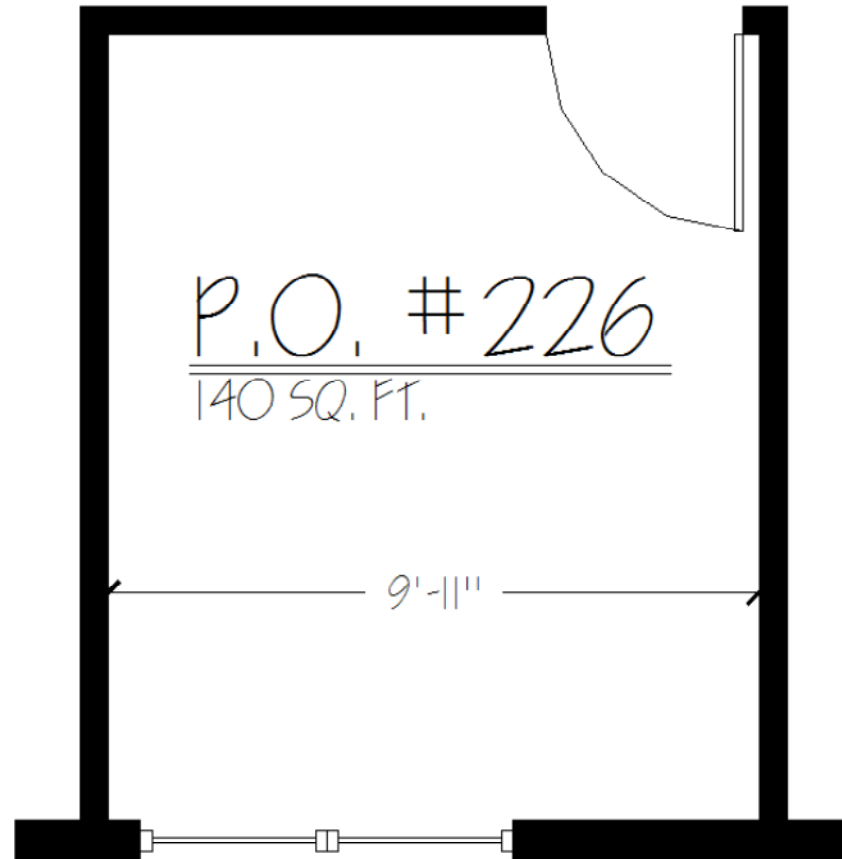

Building Innovation on Tradition

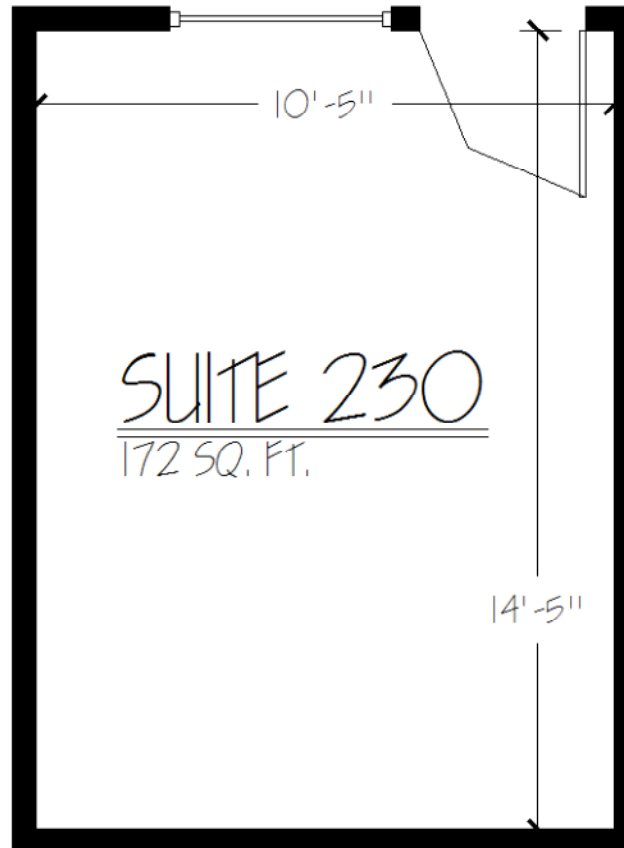

Building Innovation on Tradition

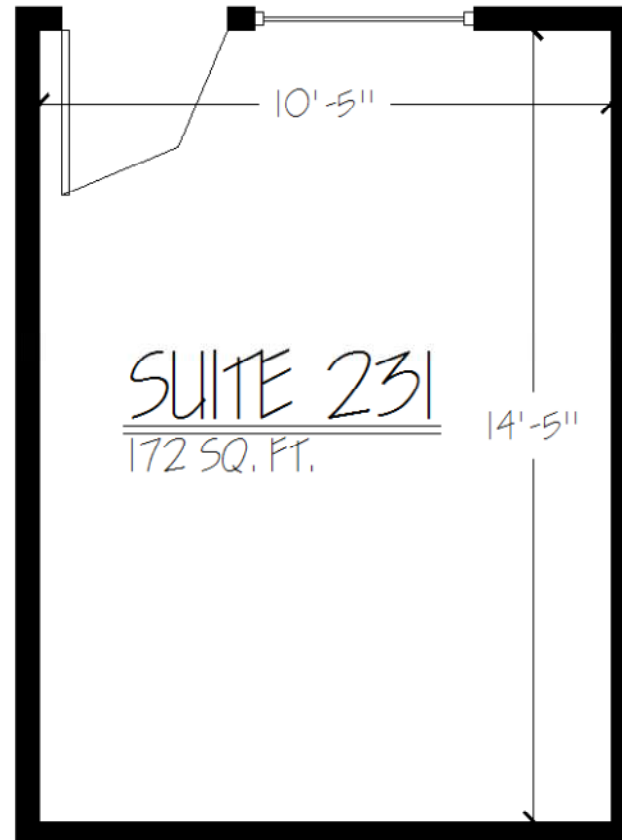

Building Innovation on Tradition

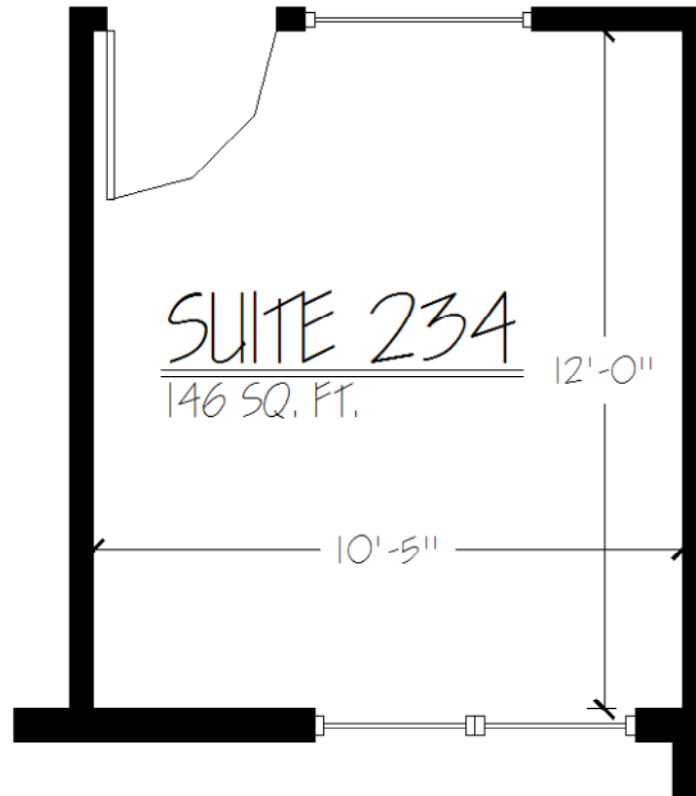

Building Innovation on Tradition

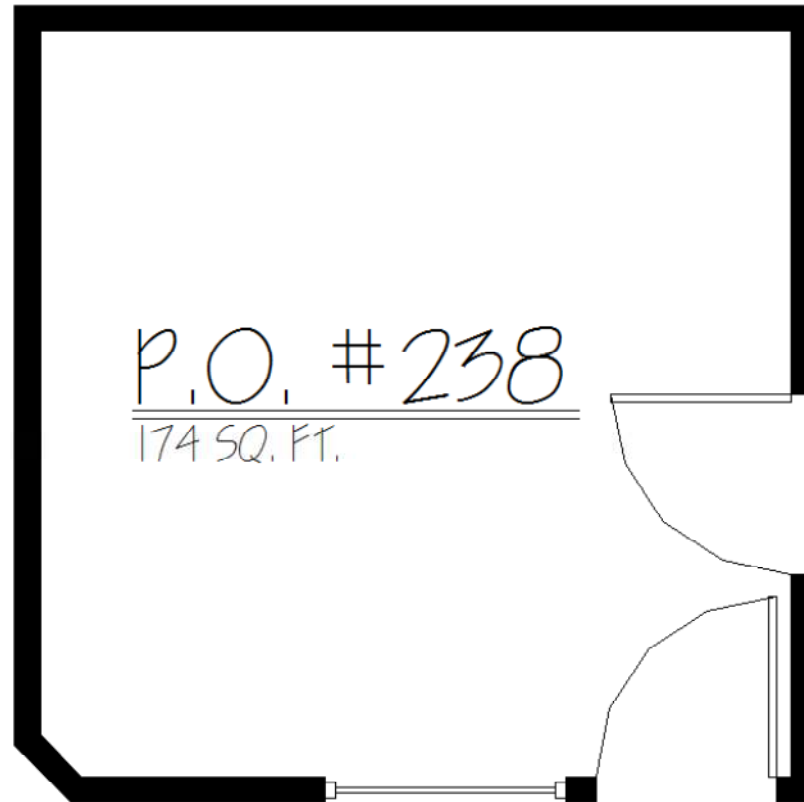

Building Innovation on Tradition

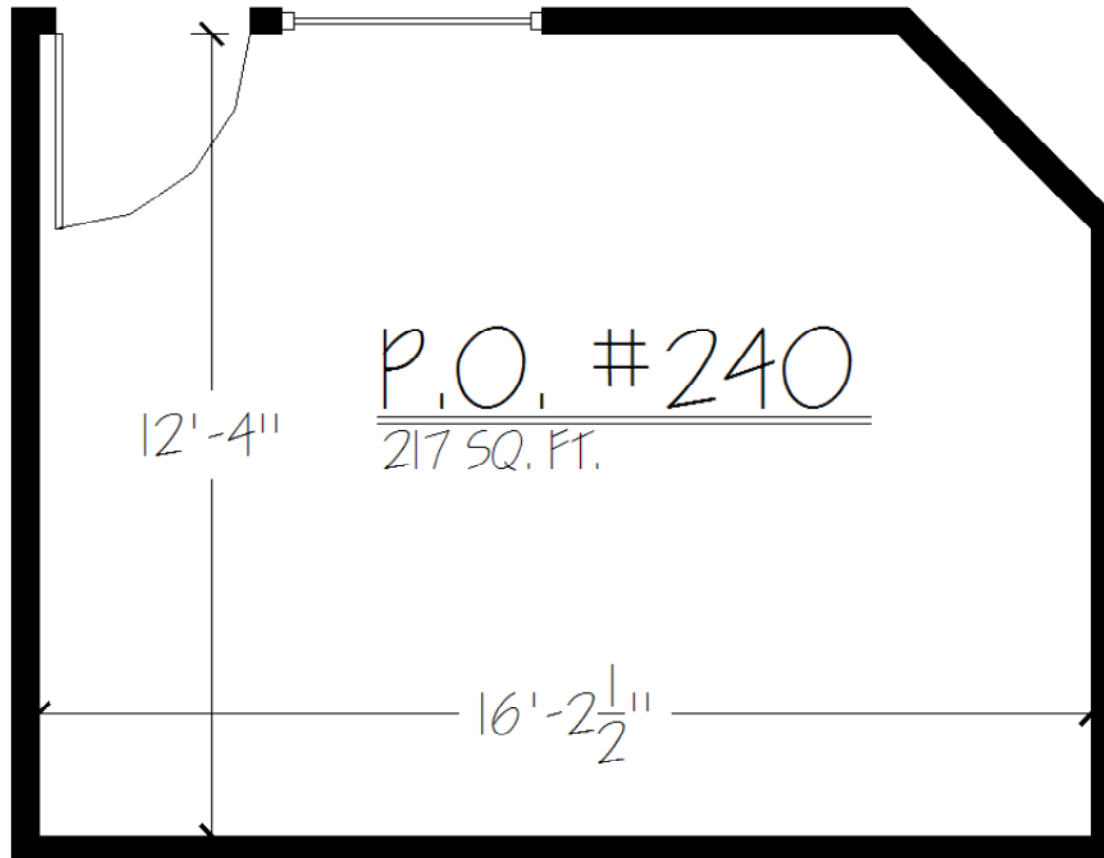

Building Innovation on Tradition



Building Innovation on Tradition

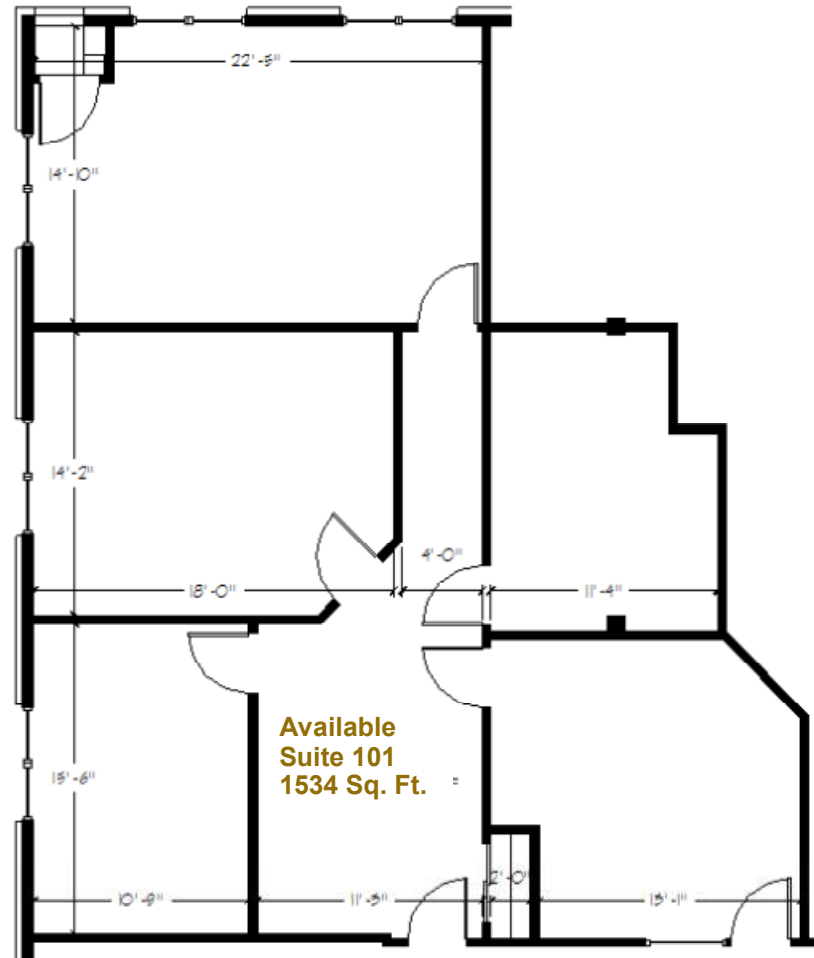

Building Innovation on Tradition

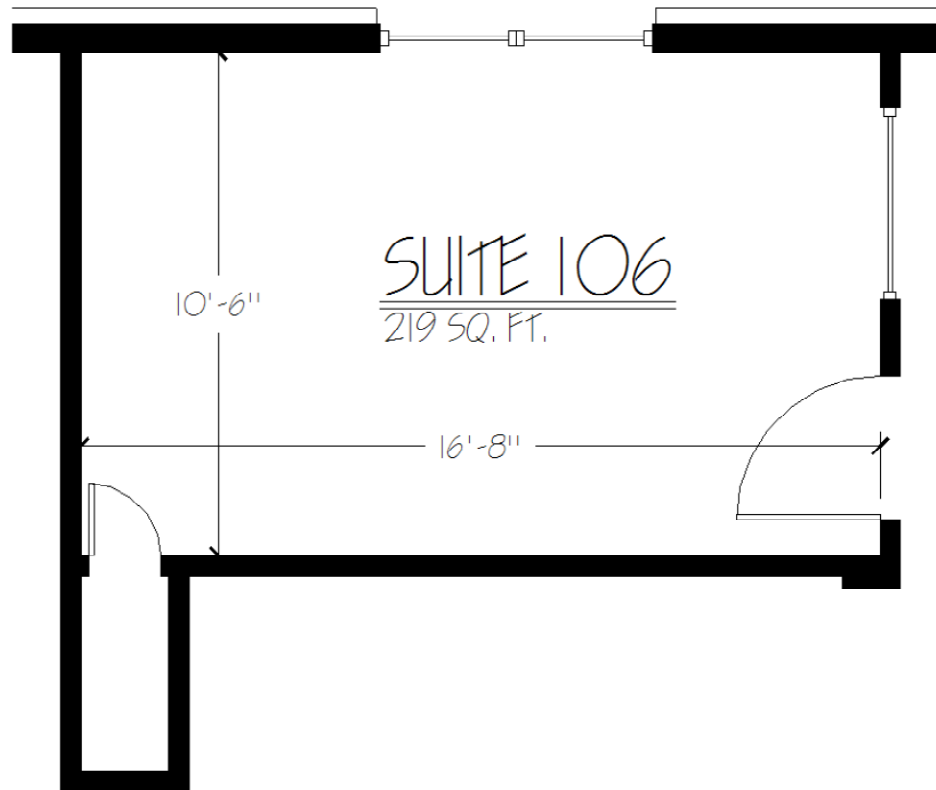

Building Innovation on Tradition

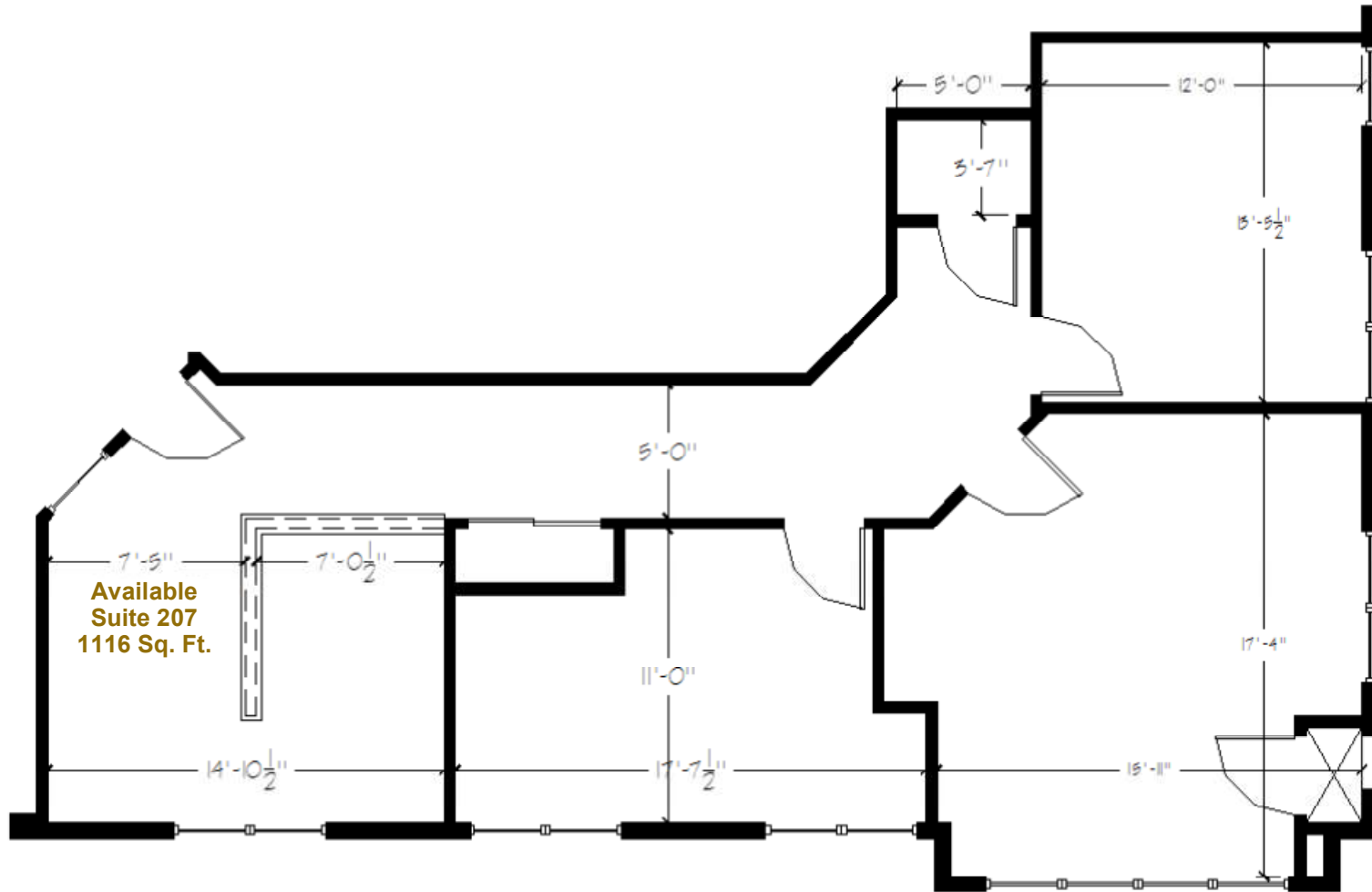

Building Innovation on Tradition

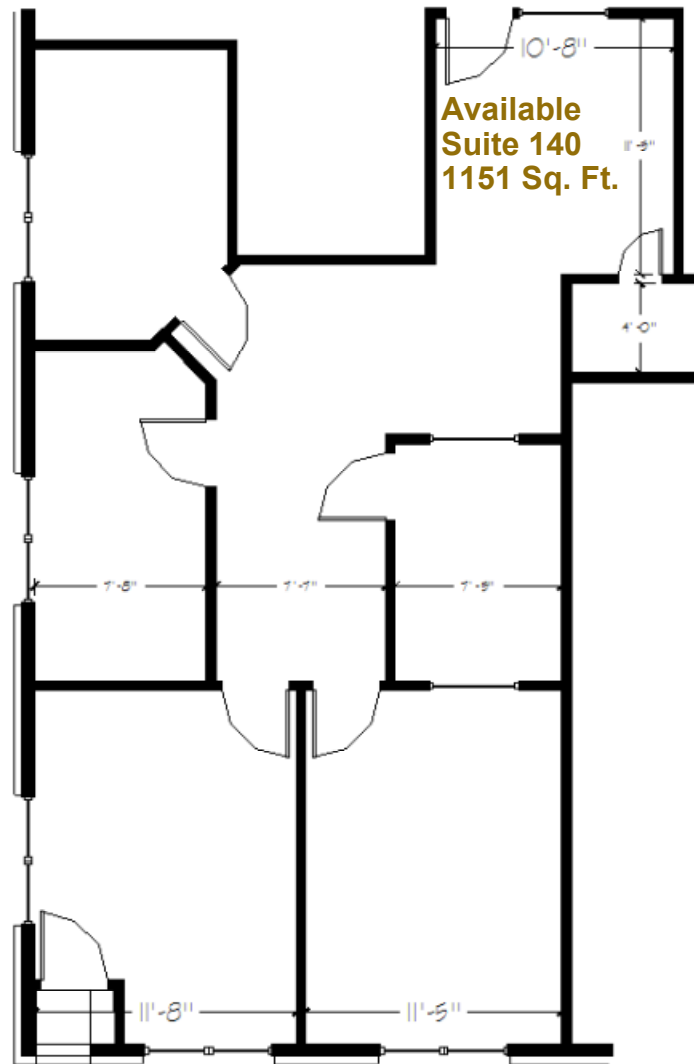

Building Innovation on Tradition

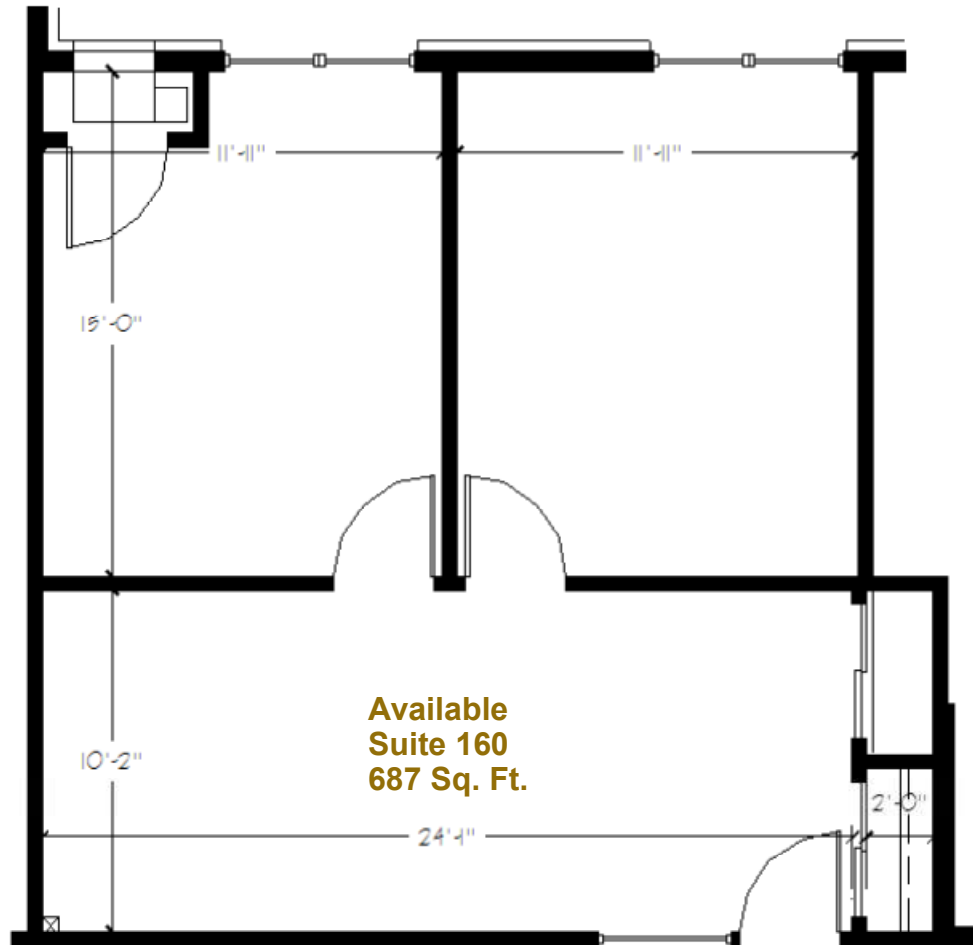

Building Innovation on Tradition

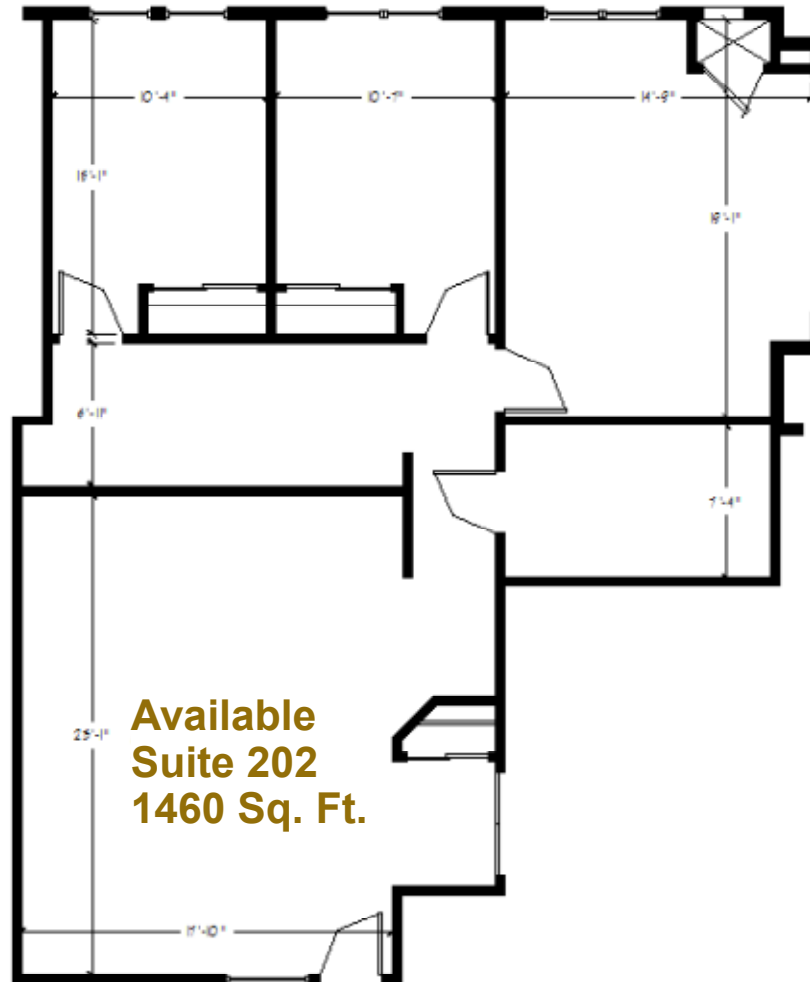

**Available
Suite 202
1460 Sq. Ft.**



Building Innovation on Tradition

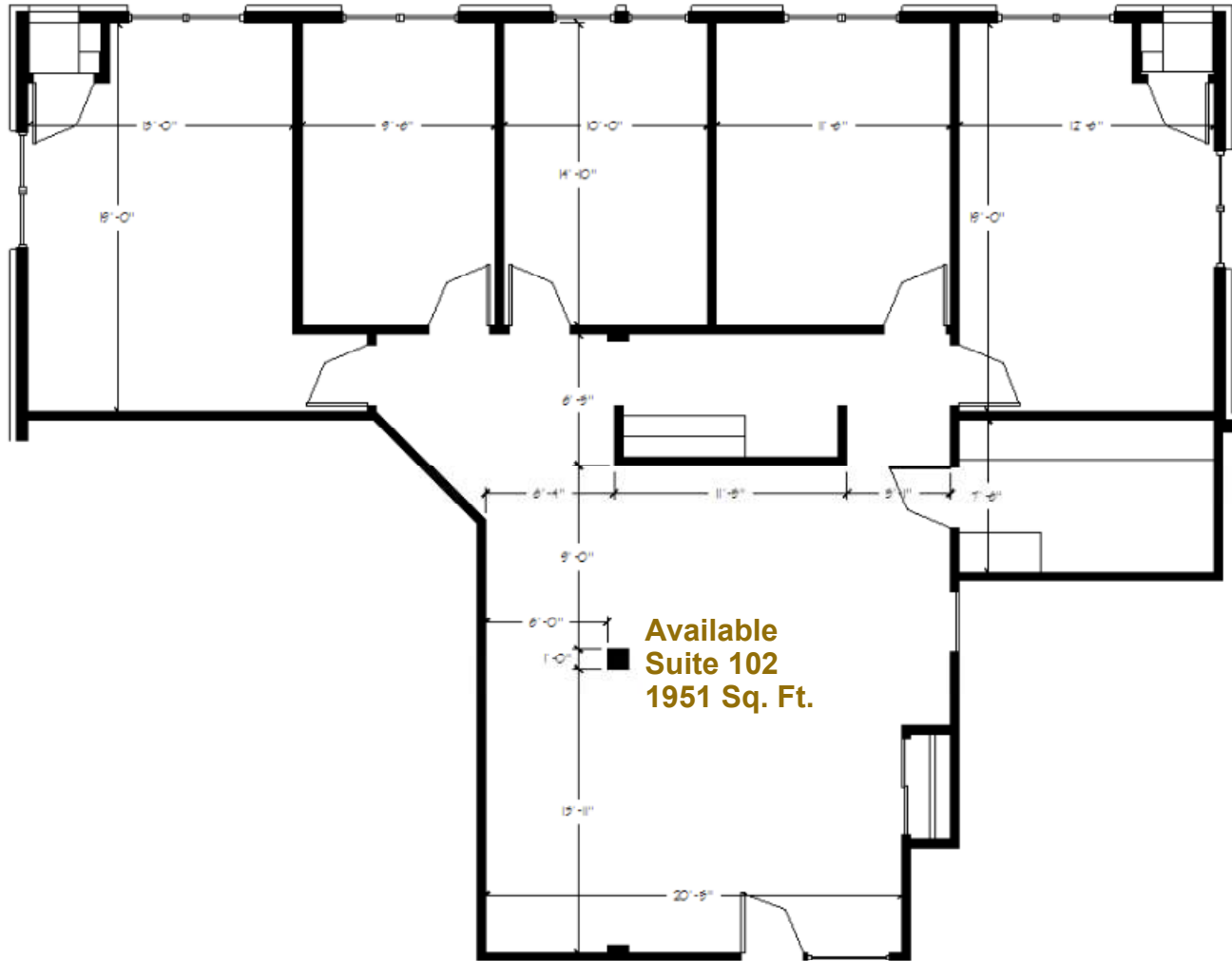

Building Innovation on Tradition

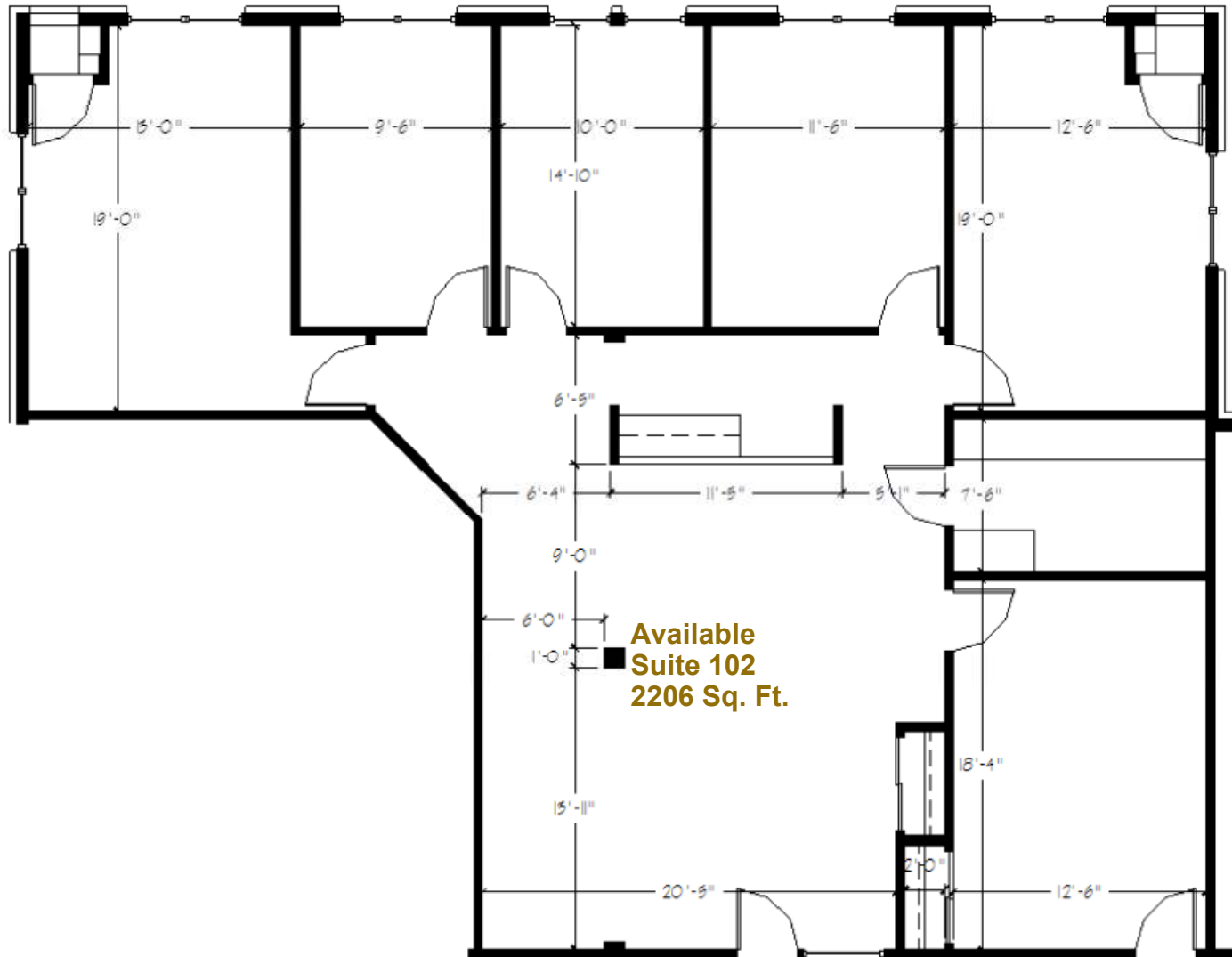

Building Innovation on Tradition

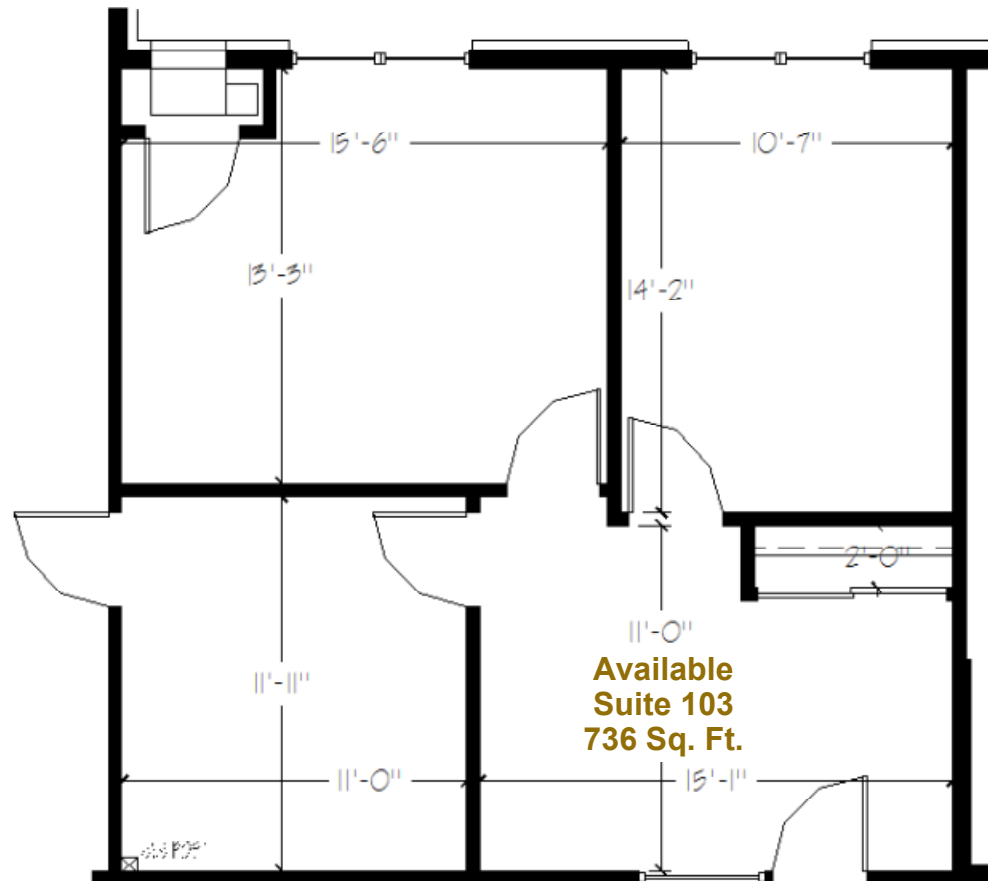

Building Innovation on Tradition

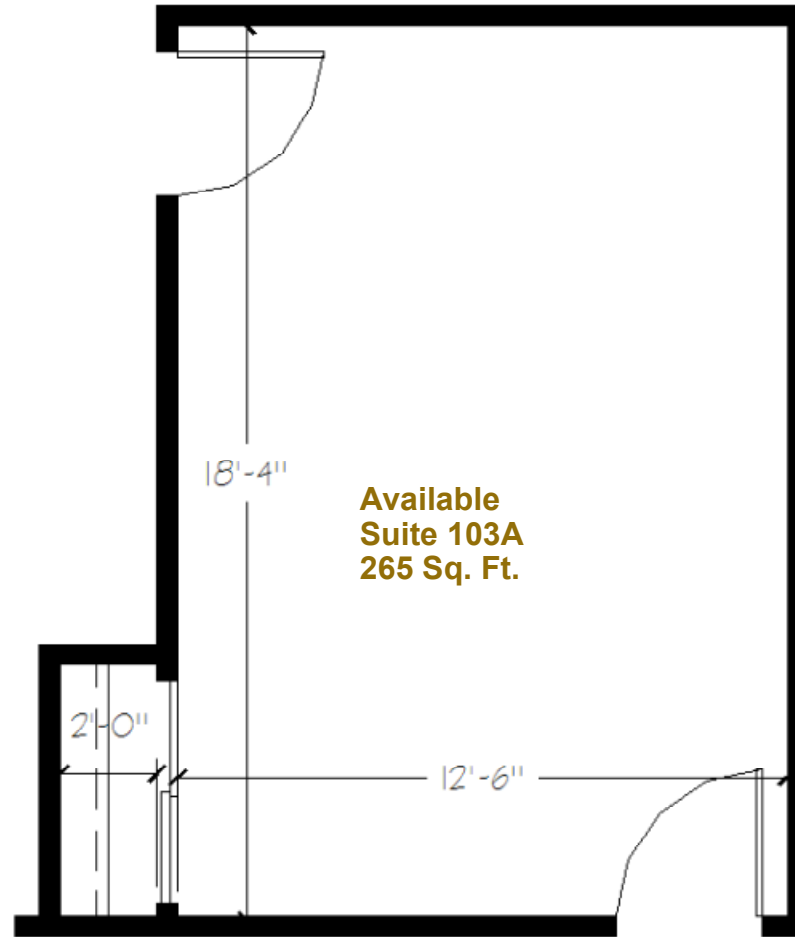

Building Innovation on Tradition

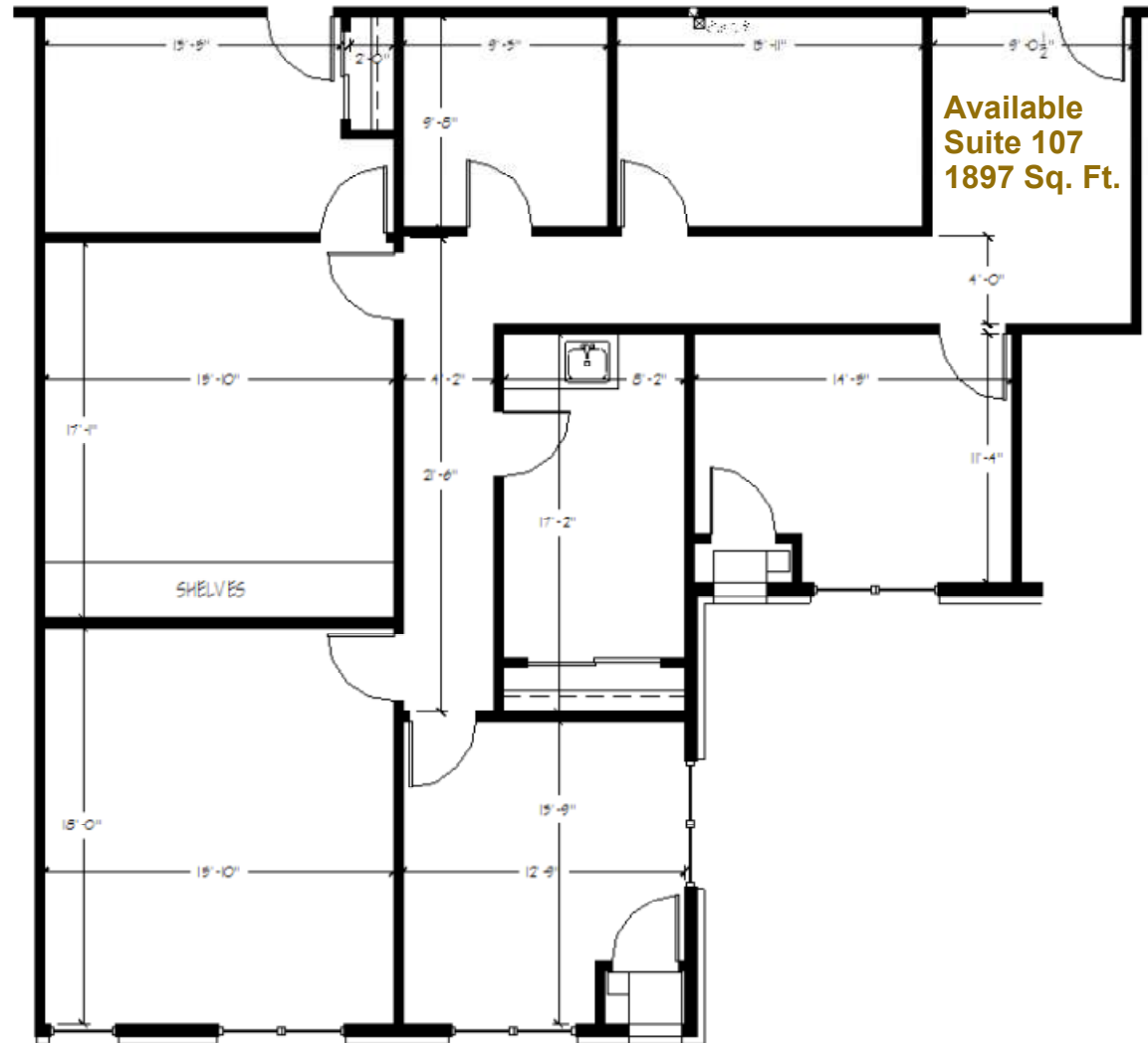

Building Innovation on Tradition

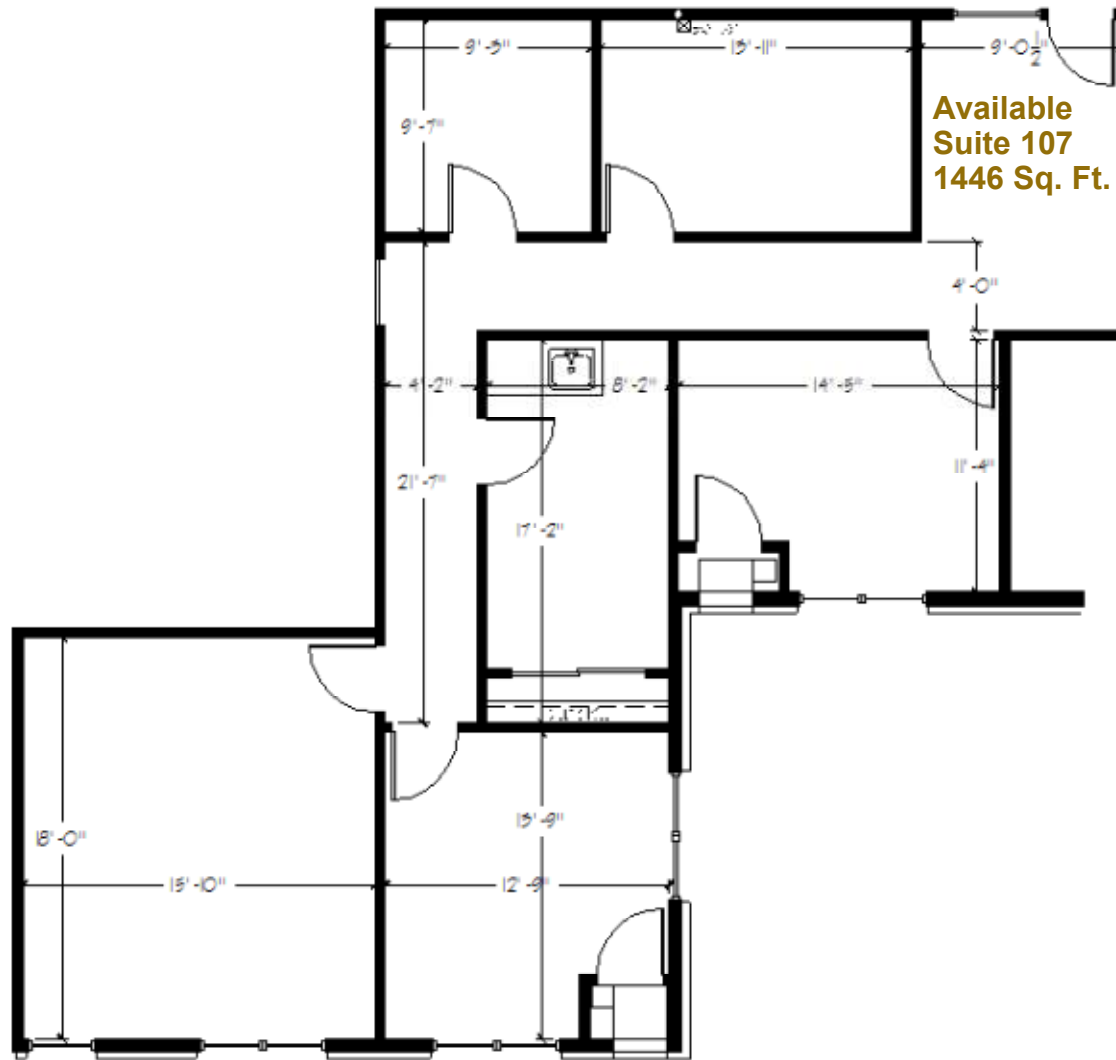

Building Innovation on Tradition

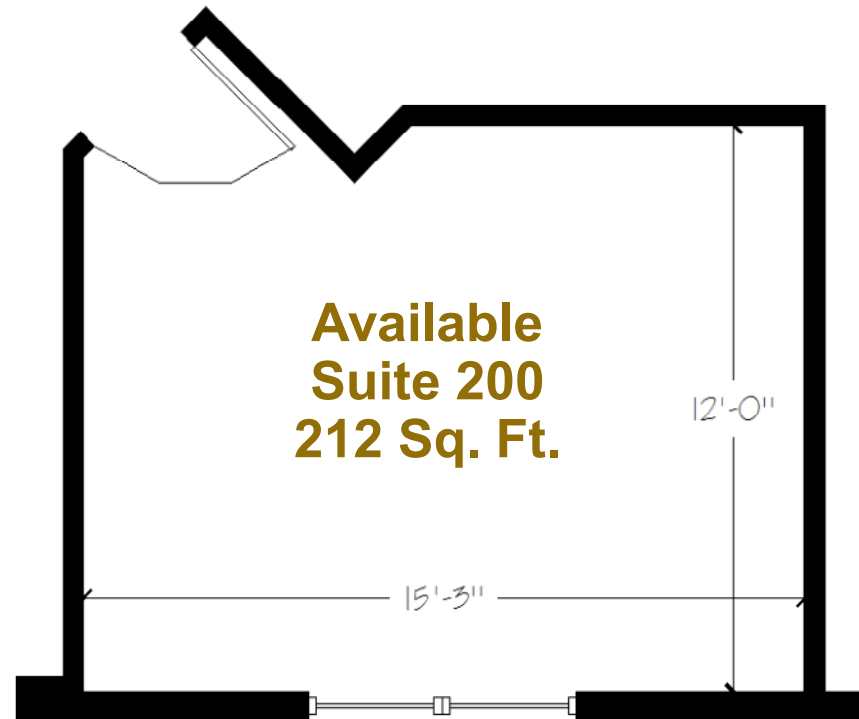

Building Innovation on Tradition